



3" Side Bar

Part No. A0058S/B



Fits: 2019 CHEVY SILVERADO 1500/ 2020
 CHEVY SILVERADO 2500-3500 DOUBLE CAB(EXCLUDES BODY
 LIFT KIT)



REMOVE CONTENTS FROM BOX. VERIFY ALL PARTS ARE PRESENT.



READ INSTRUCTIONS CAREFULLY BEFORE STARTING INSTALLATION.

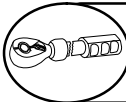

DO NOT OVER TORQUE. STANDARD OPERATING LOAD FOR TIGHTEN
 BODY MOUNT NUTS & BOLTS VARIES FROM 45 TO 65 FOOT POUND.



60-180 min

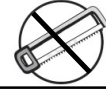

Cutting Not
 Required



Drilling Not
 Required



support@trailfx.com



1 866 638 4870



POLISHED STAINLESS STEEL - LIMITED LIFETIME
 POWDER COATED BLACK - 3 YEARS

PARTS LIST:

Qty	Part Description	Qty	Part Description
1	Driver/Left 3inch Oval Bent End Sidebar	1	Passenger/Right Rear Mounting Bracket
1	Passenger/Right 3inch Oval Bent End Sidebar	6	12mm x 24mm x 2.5mm Small Flat Washers
1	Driver/Left Front Mounting Bracket	4	1/2" x 2" Hex Bolts
1	Passenger/Right Front Mounting Bracket	4	1/2" Lock Washers
2	Center Support Brackets	4	1/2" x 1-1/2" OD x 1/8" Large Flat Washers
1	Driver/Left Rear Mounting Bracket	2	8-1.25mm x 25mm Combo Bolts

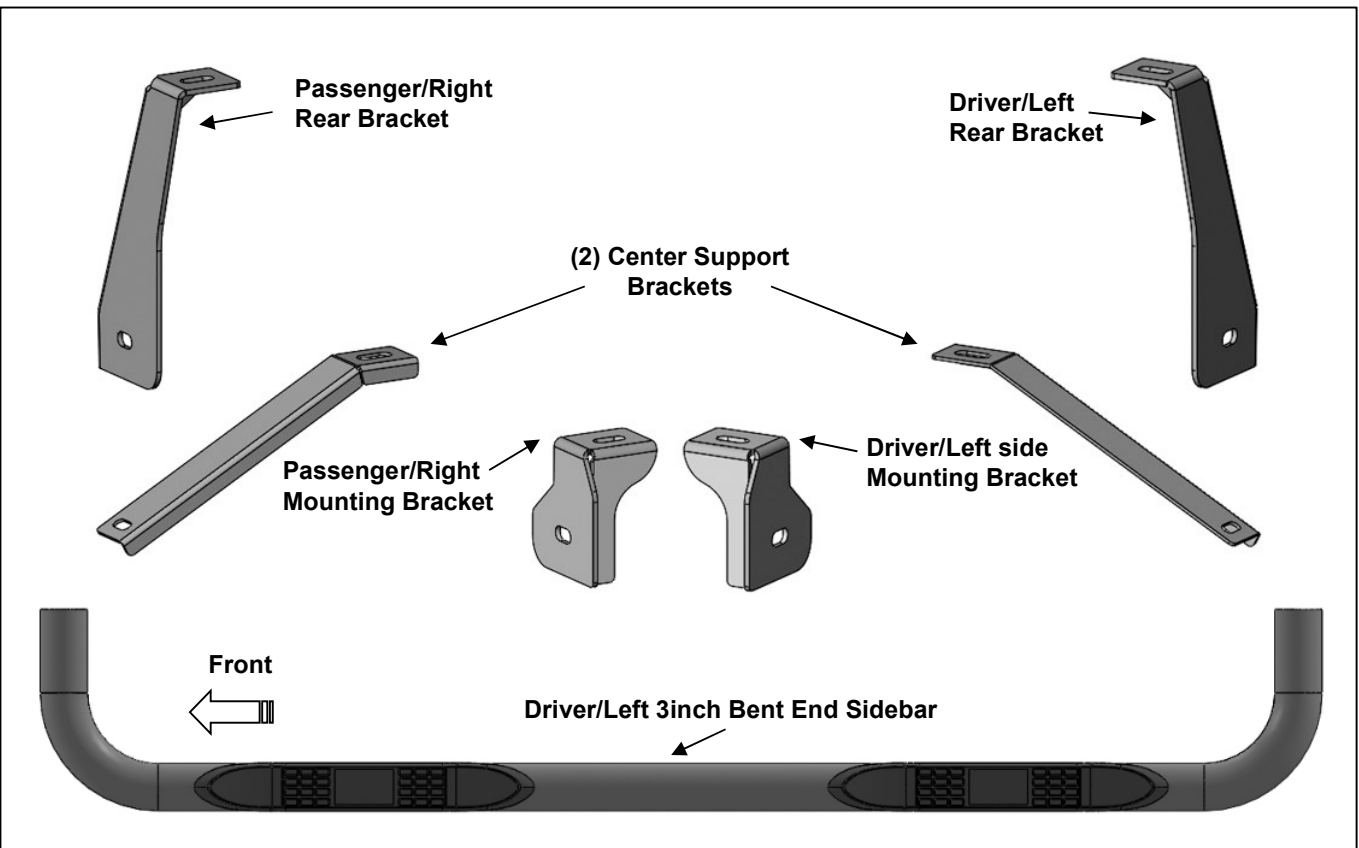

PROCEDURE:

REMOVE CONTENTS FROM BOX. VERIFY ALL PARTS ARE PRESENT. READ INSTRUCTIONS CAREFULLY BEFORE STARTING INSTALLATION. ASSISTANCE IS RECOMMENDED.

1. Start the installation under the Driver/Left side of the vehicle. Locate the front body mount. Remove the front body bolt. **Note:** 2019 1500 models have a factory flat body washer. 2020 25-3500 models have a factory cupped body washer and require a 12mm Flat Washer to create a flat surface for Mounting Bracket installation, **(Figures 1 & 2)**.
2. Select the Driver/Left Front Bracket. Line up the upper slot on the Bracket with the body bolt hole.
Determine the model of the vehicle
 - a. **For 2019 models** Reuse the factory body bolt to attach the Bracket to the top of the body mount. **(Figures 3 & 4)**.
 - b. **For 2020 models** Reuse the factory body bolt and (1) 12mm x 24mm Small Flat Washer to attach the Bracket to the top of the body mount. **(Figures 3 & 4)**.
3. Move to the center mounting location, **(Figure 5)**. Repeat **Steps 1 & 2** to attach (1) Center Support Bracket to the center body mount, **(Figures 6 & 7)**.
4. Move to the rear mounting location, **(Figure 8)**. Repeat **Steps 1 & 2** to attach the Driver/Left Rear Mounting Bracket to the rear body mount, **(Figures 9 & 10)**.
5. Carefully unwrap and select the Driver/Left Sidebar. Use the illustration above to help identify the correct Sidebar. With assistance, line up the front end of the tube with the front Bracket slot, **(Figure 11)**. Use (1) 1/2" Hex Bolt, (1) 1/2" Lock Washer and (1) 1/2" Flat Washer to attach the front end of the Sidebar tube to the Front Bracket, **(Figure 12)**. Do not tighten hardware at this time.
6. Attach the Sidebar to the Center Support Bracket using (1) 8mm Combo Bolt, **(Figures 13 & 14)**. Do not tighten hardware at this time.
7. Repeat **Step 5** to attach the rear end of the Sidebar to the Rear Bracket, **(Figures 15 & 16)**.
8. Level and adjust the Sidebar as necessary and fully tighten all hardware.
9. Repeat **Steps 1—8** for Passenger/Right Sidebar installation.
10. Do periodic inspections to the installation to make sure that all hardware is secure and tight.

Driver/Left Side Installation Pictured

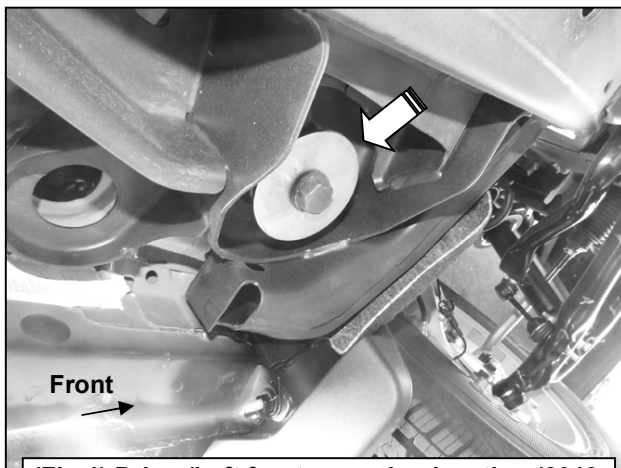

(Fig 1) Driver/Left front mounting location (2019 1500 model with flat body bolt washer shown)



(Fig 2) Driver/Left front mounting location (2020 25-3500 model with cupped body bolt washer shown)

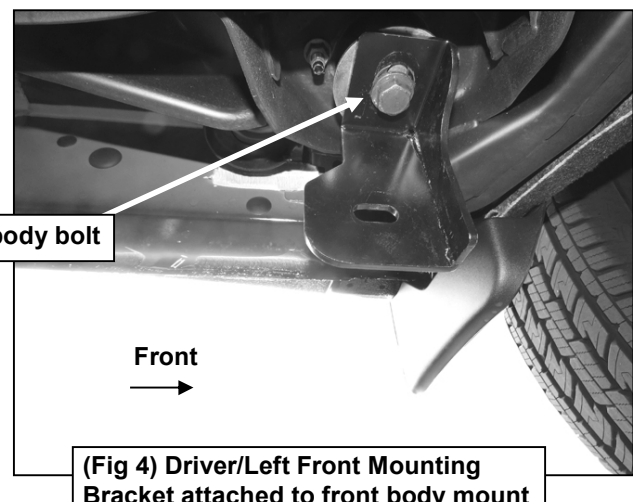
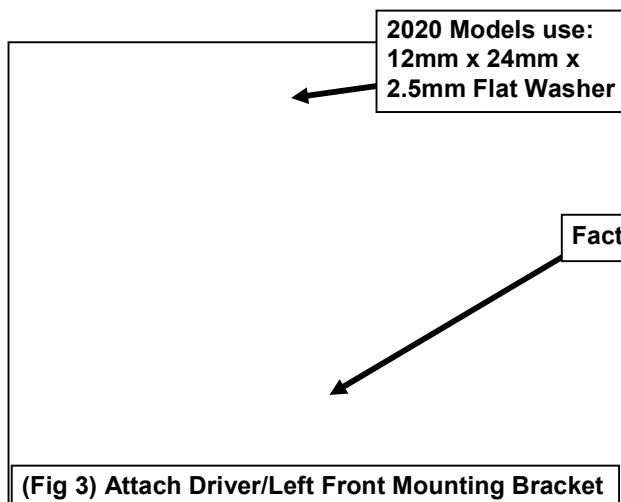

(Fig 4) Driver/Left Front Mounting Bracket attached to front body mount

Driver/Left Side Installation Pictured

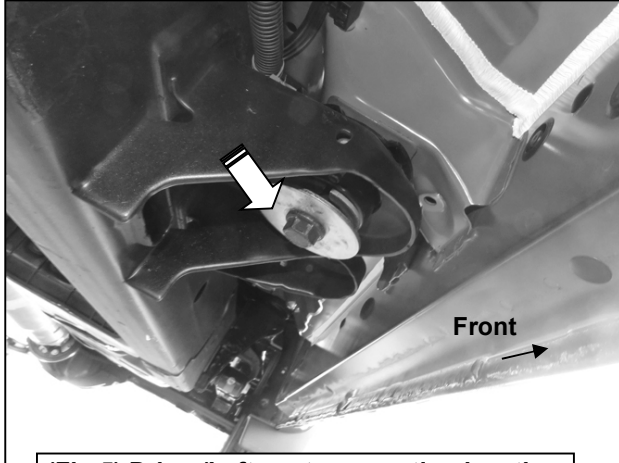

(Fig 5) Driver/Left center mounting location

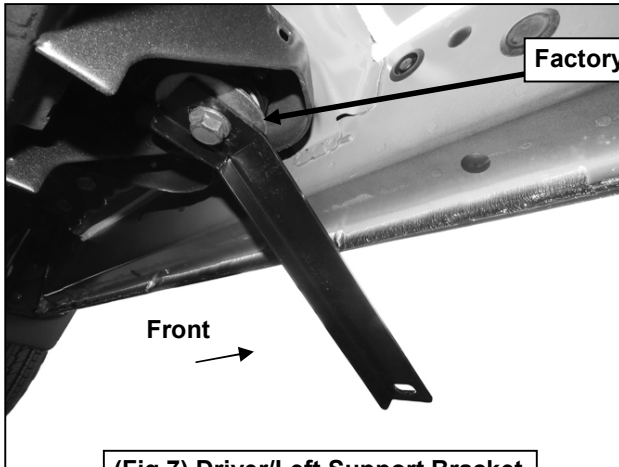

(Fig 7) Driver/Left Support Bracket attached to center body mount

2020 Models use:
12mm x 24mm x
2.5mm Flat Washer

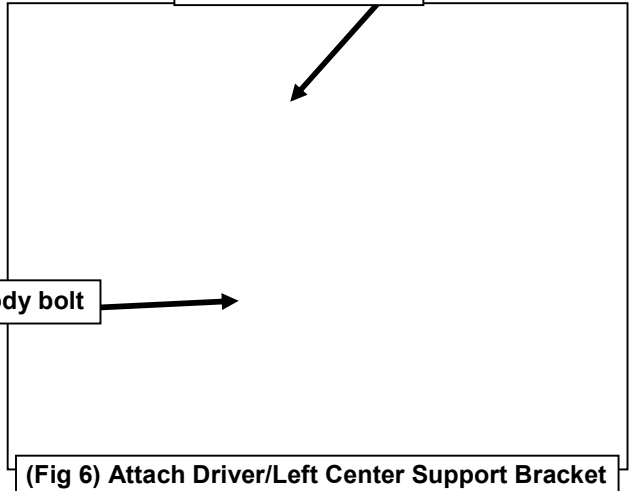

(Fig 6) Attach Driver/Left Center Support Bracket

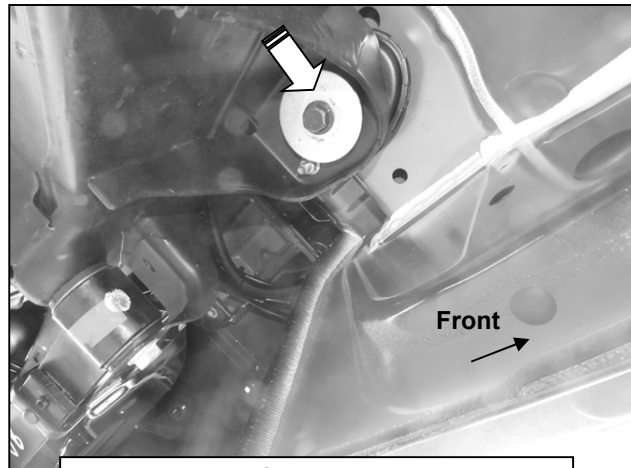

(Fig 8) Driver/Left rear mounting location

Driver/Left Side Installation Pictured

2020 Models use:
12mm x 24mm x
2.5mm Flat Washer

Factory body bolt

(Fig 9) Attach Driver/Left Rear Mounting Bracket

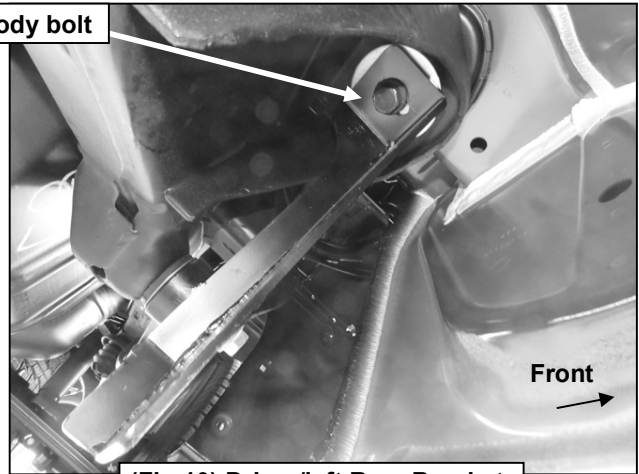

(Fig 10) Driver/left Rear Bracket attached to the rear body mount

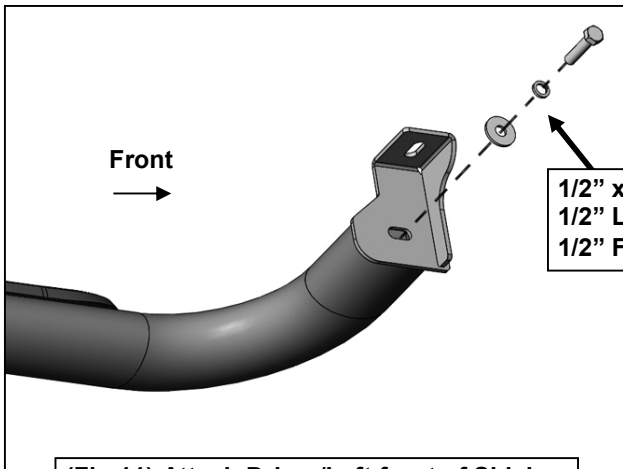

(Fig 11) Attach Driver/Left front of Sidebar attached to Front Mounting Bracket

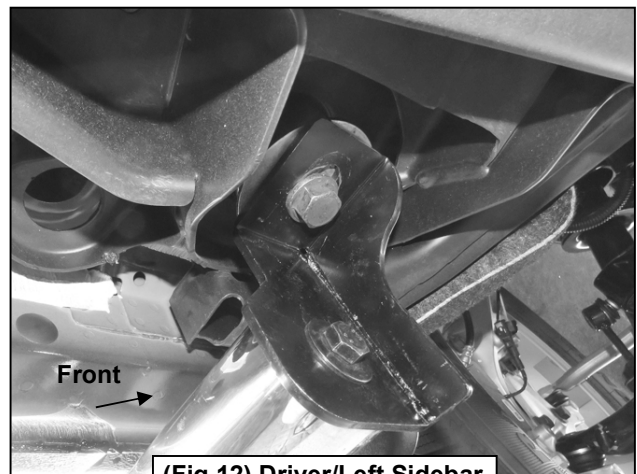

(Fig 12) Driver/Left Sidebar attached to Front Bracket

Driver/Left Side Installation Pictured

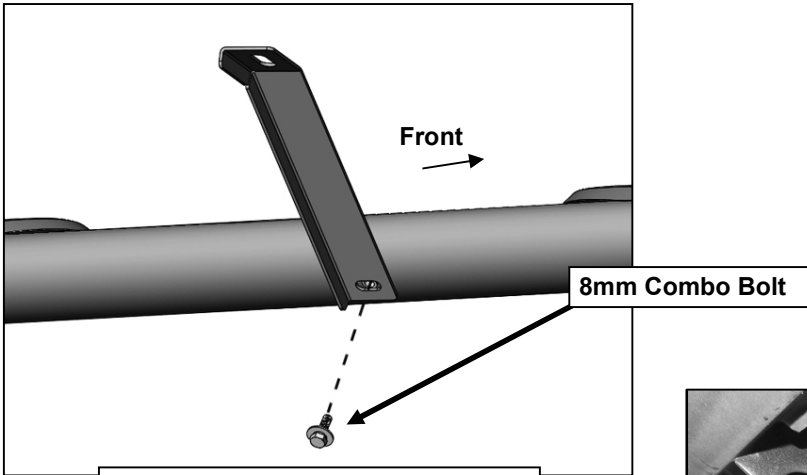

(Fig 13) Attach Driver/Left center of Sidebar to Center Support Bracket

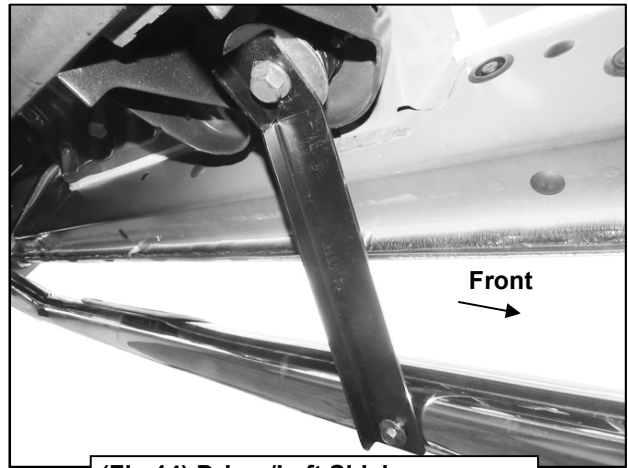

(Fig 14) Driver/Left Sidebar attached to Center Support Bracket

1/2" x 2" Hex Bolt
1/2" Lock Washer
1/2" Flat Washer

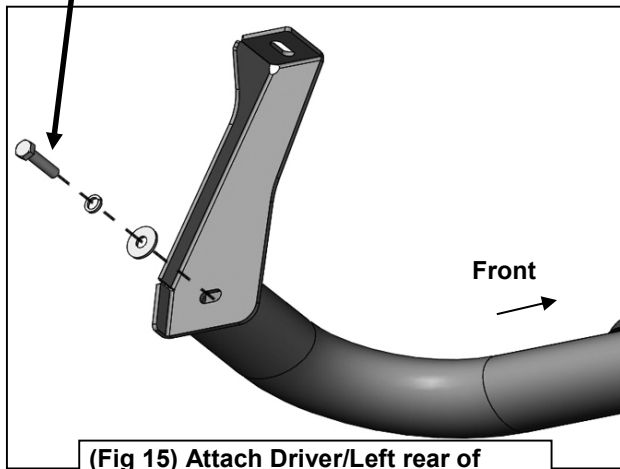

(Fig 15) Attach Driver/Left rear of Sidebar to the Rear Mounting Bracket

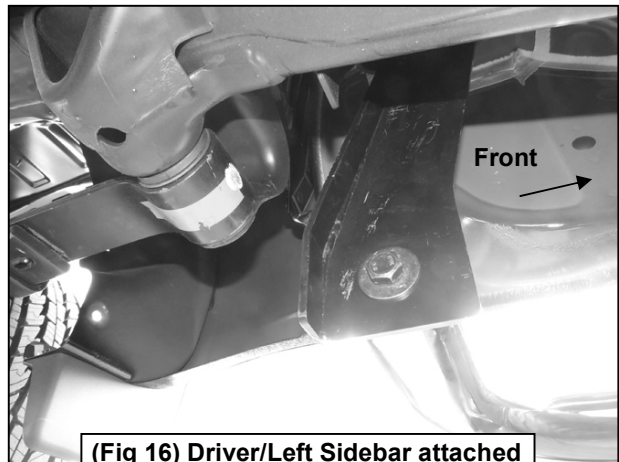

(Fig 16) Driver/Left Sidebar attached to the Rear Mounting Bracket

PARTS IDENTIFICATION GUIDE

Driver Side tube packed using "Green" color foam sheet. Passenger Side tube packed using "White" color foam sheet

No.	Parts Identification
1	Passenger / Right 'Rear' Bracket marked "PR"
2	Driver / Left 'Rear' Bracket marked "DR"
3	Passenger / Right 'Center' Bracket marked "PC"
4	Driver / Left 'Center' Bracket marked "DC"
5	Passenger / Right 'Front' Bracket marked "PF"
6	Driver / Left 'Front' Bracket marked "DF"

Note:

- > This guide is to identify the parts and not a reference for part count.
- > For part count, refer Parts List.
- > Product / Bracket image is representative and actual design may vary.

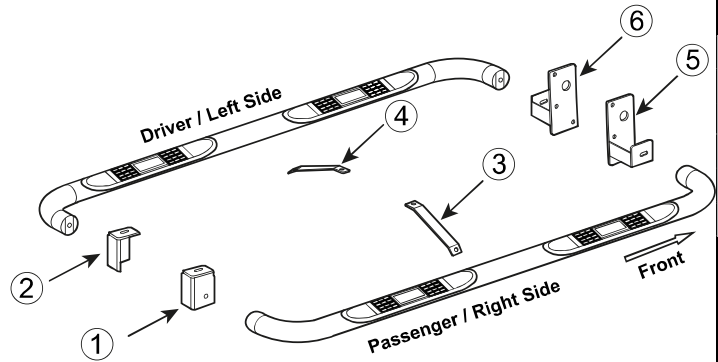
**PRODUCT CARE**

- Periodically check the product to ensure all fasteners are tight and components are intact.
- Regular waxing is recommended to protect the finish of the product.
- **Use ONLY Non-Abrasive automotive wax.** Use of any soap, polish or wax that contains an abrasive is detrimental and can scratch the finish leading to corrosion.
- Aluminum polish may be used to polish small scratches and scuffs for **Stainless Steel finish.**
- Mild soap may be used to clean the product for both **Stainless Steel and Black finish.**

FAQ's**1. Hardware's are not of correct size.**

In GMC / Chevrolet truck model 2006 & up, customer needs to reuse the factory body bolts to install the bracket. If your vehicle is not GMC / Chevrolet 2006 & up, ensure that holes are not partially covered with any plastic grommet or rust? If it is, remove the plastic grommet & rust from the thread holes & re-try the installation.

2. Mounting Bracket are not getting Installed properly.

In some cases Illustration images shown in Installation manual may not be the exactly same as per actual vehicle images ,also if Driver / Passenger side mounting brackets are very identical in the design, suggest referring Parts Identification guide to avoid fitment issue.

3. Products are thumping / rattling after installation.

Ensure that all required mounting brackets / hardware's are installed & tighten correctly. Suggest using white lithium / regular grease between the metal to metal contact surfaces.

4. Side Bar is not aligning with vehicle / Step Pads are not aligning with vehicle doors.

Side bar may be interchanged or mounting brackets are not installed at the correct position in the vehicle. Refer Parts identification guide.

5. Missing / Excess Hardware.

Recheck hardware count as per the part list.

6. Product not installing properly.

Ensure make model year, cab length and bed size of your vehicle is listed in the application. All installation steps are followed correctly.

Check out these other TrailFX Products!!

www.TrailFX.com



Keystone Automotive Operations Inc. (KAO) warrants this product to be free of defects in material and workmanship at the time of purchase by the original retail consumer. KAO disclaims any other warranties, express or implied, including the warranty of fitness for a particular purpose or an intended use. If the product is found to be defective, KAO may replace or repair the product at our option, when the product is returned prepaid, with proof of purchase. Alteration to, improper installation, or misuse of this product voids the warranty. KAO's liability is limited to repair or replacement of products found to be defective, and specifically excludes liability for any incidental or consequential loss or damage.